

A low-angle photograph of an industrial facility, likely a refinery or chemical plant, featuring large, complex piping systems and structural steel frameworks against a clear blue sky. In the foreground, a man wearing a white hard hat, safety glasses, and a dark blue polo shirt is looking upwards, his face partially in shadow. The overall color palette is dominated by blues and reds.

hibon[®]

*Blowers and
low pressure compressors*
for air and gases

IR Ingersoll Rand
Industrial Technologies

The reference name in the pressure business

With experience dating back more than a century, the Ingersoll Rand group offers to the market a world-class range of air blowers and compression equipment used to provide air/gas volumes at varying pressures above atmospheric, and for vacuum duties.

Today HIBON is part of Ingersoll Rand and wants to offer its customers the experience and the responsiveness of this well known multinational organisation. Our objective is to supply quality products together with top level service anywhere in the world.

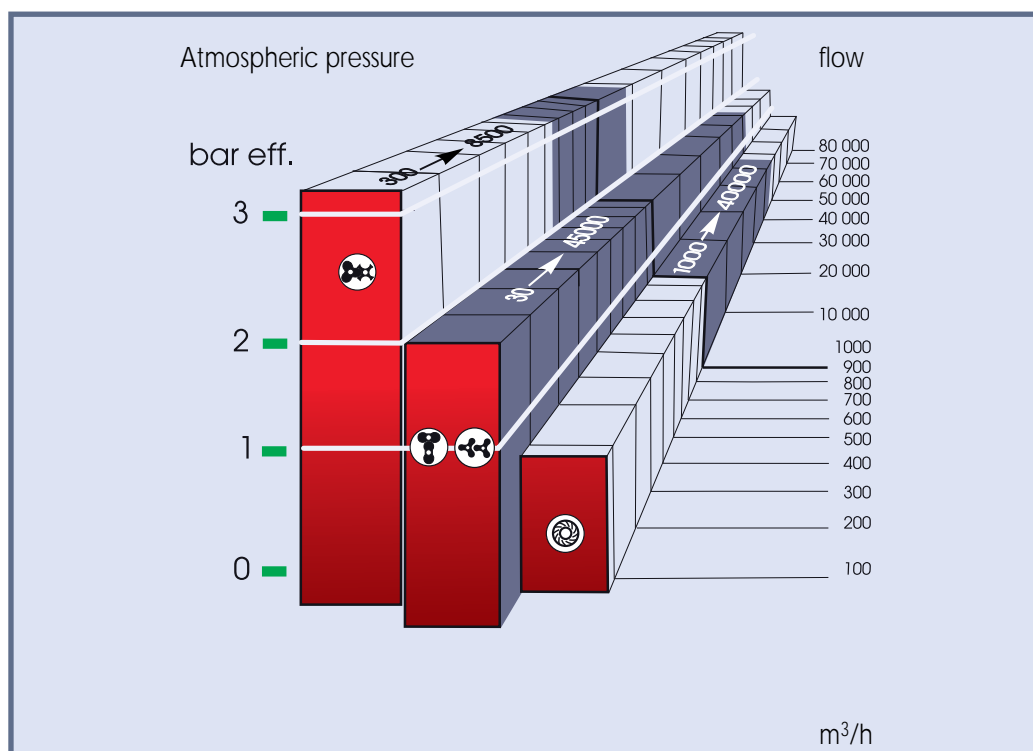

A strategy aimed at performance and quality







Our policy of continuous innovation and development means great emphasis is placed on a strategic programme within the enlarged group to offer state of the art solutions to better meet market expectations.

Our main aims are : reducing noise emissions, reducing power consumption, ease of maintenance, measurable improvement in productivity.

ISO 9001 certified for the design, manufacture and maintenance of blowers and compressors, INGERSOLL RAND are dedicated to quality, through the quality of its people and performance of their production equipment.



Range of Products







	Product	Flow	Vacuum / Pressure
	Positive Displacement Blowers	20-25000 m ³ /h 12-14705 cfm	500 mbar abs (15" Hg) 1 bar eff (14.5 psig)
	Vacuum Air Injection Blowers	100-9000 m ³ /h 59-5294 cfm	80 mbar abs (24" Hg)
	Dry Bulk Truck Pressure Blowers (Truckstar)	110-1700 m ³ /h 65-1000 cfm	500 mbar abs (15" Hg) 1,2 bar eff (17.4 psig) (intermittent)
	Process Blowers (Special Seals & Materials)	20-25000 m ³ /h 12-14705 cfm	500 mbar abs (15" Hg) 1,8 bar eff (26 psig) (two-stage)
	Water injection positive displacement blowers	20-45000 m ³ /h 12-26470 cfm	500 mbar abs (15" Hg) 1 bar eff (14.5 psig)
	Oil Free Screw Compressors	300-8500 m ³ /h 177-5000 cfm	250 mBar abs (7.4" Hg) 3,5 bar eff (50 psig)
	Multistage Centrifugal Blowers	1000-40000 m ³ /h 589-23530 cfm	500 mbar abs (15" Hg) 1,1 bar eff (16 psig)

Other Solutions

Ingersoll Rand Air Solutions today encompasses a full range of solutions starting with air compressors using all compression technologies, and including air and cooling water treatment systems, turnkey installations, Auditing services and AirCare programs.

By offering single-source system capability from implementation to operation, Ingersoll Rand provides customers with reliable, energy efficient and cost saving air system solutions, allowing customers to focus on their operation and never have to worry about the quality of their compressed air.

A multi market positioning

Markets	Applications	 Standard Blowers	 SME	 SIAV	 TS	 Process	 HCS
Industrial	Fixed or mobile pneumatic conveying	X		X	X		X
	Centralised cleaning systems	X	X	X			
	Vacuum handling systems			X			
	Fluidisation	X				X	
	Cristallisation					X	
	Compressed air for ballasting		X				X
	Mechanical steam compression					X	
	Desulfurisation		X				X
	Sonar interference	X					
Environment	Filtration					X	
	Biological aeration	X	X				X
	Biogaz recovery / Methane suction		X			X	
	Filter cleaning	X	X				X
	Sewage treatment			X			
Cement and minerals	Digestors					X	
	Oxydation		X			X	
	Combustion air						X
	Gas desulfurisation		X			X	X
Chemical Industries	Homogenisation	X					
	Mechanical steam compression					X	
	Vacuum filtration					X	
	Boiler feed					X	
	VSA (Vacuum Swing Absorption)					X	
Pulp Paper	Gas circulation					X	
	Felt conditioning					X	
	Impregantion / Dewatering					X	
	Band filter dewatering					X	
Energy / Power	Centralised cleaning systems / Vacuum handling systems	X	X	X			X
	Dust removal / Air for fluidised beds		X				
Transport (Truck market)	Fluidisation	X	X				X
	Pneumatic conveying			X	X		
	Compressed air for ballasting				X		X
	Gas Liquifying				X		
	Carriage pressurization				X		X

Field Service

Global customer support efficiency, guaranteed, and fast

■ Repair in our workshop

- Capability and infrastructure
- Environmental, health & safety approved
- Fast turn-around
- Urgent repairs
- Special reports

■ Spare parts

- Kan Ban stock
- Fast delivery
- Service kits for routine product maintenance

■ Service Exchange

- Standard exchange offer
- Tested
- Guaranteed

■ On site service

- Fast response
- On site training
- Advice and technical support
- Specific service contract

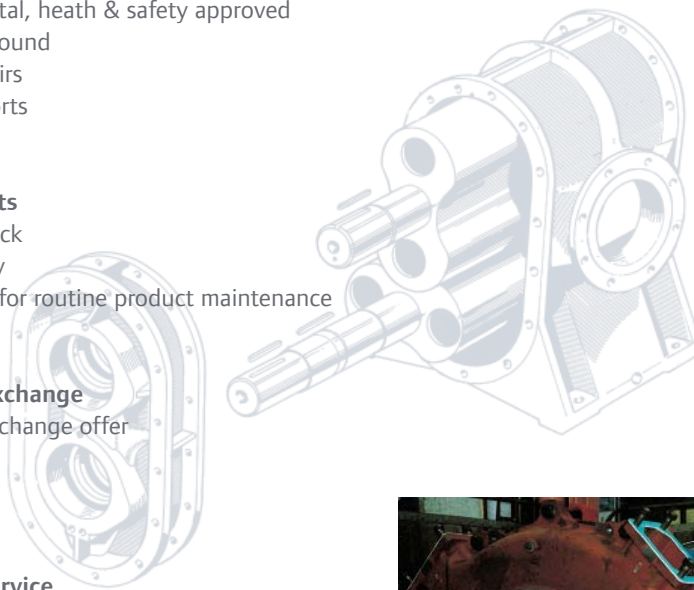

Standard positive displacement Blowers



S2H22>S2H52 series

- Flows from 35 m³/h (20 cfm) to 1 150 m³/h (675 cfm)
- Pressures to 1 bar g.* (14.5 psig)
- Vacuum to 500 mbar abs (15 "Hg)
- Two lobe construction.
- Four bearings standard with drive shaft suitable for V-belt and direct drives.
- Bearing life : 50 000 hours.
- Available in 50 mm (2"), 75 mm (3"), 100 mm (4") and 125 mm (5") gear sizes.



SN series

- Flows from 20 m³/h (12 cfm) to 25 000 m³/h (14705 cfm)
- Pressures to 1 bar g.* (14.5 psig)
- Vacuum to 500 mbar abs (15 "Hg)
- Tri-lobe construction with built-in pulse control system to reduce pulsations and noise.
- Five bearings standard with drive shaft suitable for V-belt and direct drives.
- Oil splash lubricated bearings for long service.
- Piston rings and labyrinth seals.
- Heavy duty casing and end plates with cast ribs for strength.
- Heavy duty roller bearing at shaft end.
- Helical gears located on the drive end for more input torque capability.
- Better balancing to withstand fatigue.

* Depending on the model

Truckstar Blowers

- The Truckstar range has been developed specifically for dry bulk transfer applications on trucks for the cement, fly ash, lime, flour, powder, sugar, plastic pellets, sand grain industries...

- Flows of 1100-1700 m³/h (647-1000 cfm)

- Pressure to 1.2 bar (17.4 psig) gauge

- Vacuum to 500 mbar abs (15 "Hg)

- Tri-lobe construction with pulsation control ports for smoother operation.
- Clockwise and anti-clockwise rotation.
- Oil splash lubricated bearings and large capacity sumps.
- Double ring feder and gear retainers for more input torque capability.
- Heavy duty casting ribbed for rigidity and noise attenuation.
- Built-in melting plugs for temperature protection.



Vacuum Air Injection Blowers

• SIAV-VTB series

- Flows of 100 -9000 m³/h (59-5294 cfm)

- Pressure to 1 bar (14.5 psig) gauge

- Vacuum to 80 mbar abs (24 "Hg)

- Air-cooled.
 - Tri-lobe construction to reduce pulsations, noise level and vibrations.
 - Five bearings standard with drive shaft suitable for V-belt and direct drives.
 - Helical gears located on the drive end for more input torque capability.
 - Oil lubrication and large oil sumps to improve bearing life.
 - No need for vacuum relief valve.
Can operate even with blanked inlet.
 - High vacuum and efficient on wet and dry products.
 - VTB 820 A with Spark resistant bronze impellers in accordance with ADR 2002.
- Available as packages



Blowers Package



Silent flow

- High pressure range (13 models)
- Medium pressure range (9 models)
- Flows from 15 m³/h (9 cfm) to 9 000 m³/h (5294 cfm)
- For air and neutral gases
- Differential pressure to 1 bar (14.5 psig) gauge
- Vacuum to 500 mbar abs (15 "Hg)
- Minimum footprint.
- Easy filter and oil changes.
- New ergonomic and compact design.
- High noise attenuation.
- Automatic belt tensioning system.
- Enclosure developed to meet stringent noise levels.
- Forced ventilation by motorized fan unit.
- Extended range giving optimum blower package selection capability for any duty.
- Package totally CE safety compliant.
- Silencers EPD compliant (European Pressure Directive).



Bloc 1

- Flows from 40 m³/h (24 cfm) to 14 000 m³/h (8235 cfm)
- Differential pressure to 1 bar (14.5 psig) gauge
- Vacuum to 500 mbar abs (15 "Hg)
- For air and neutral gases.
- Oil free compression.
- Easy filter cartridge change.
- Enclosure available.



Baseplate design

- Flows from 15 m³/h (9 cfm) to 25 000 m³/h (14705 cfm)
- Differential pressure to 1 bar (14.5 psig) gauge

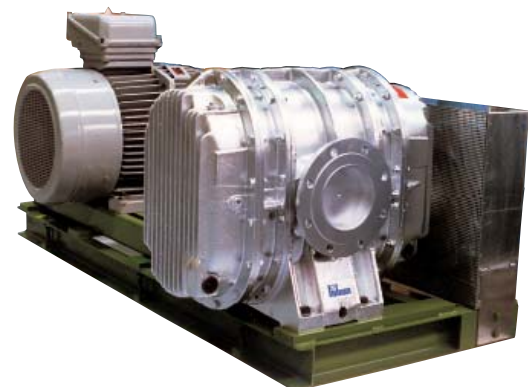

Multistage Centrifugal Blowers

SME and V-CENTRIF series

- Flows 10000-40000 m³/h (5883-23530 cfm)
- Pressure to 1.1 bar (16 psig) gauge
- Vacuum to 500 mbar abs (15 "Hg)
- Vertically split cast iron casing.
- Cast or riveted type impellers dynamically balanced.
- Carbon ring seals to reduce air leakage and improve efficiency.
- Cast aluminium bearing housing for better heat dissipation.
- Oil splash lubricated bearings with constant level oiler to ensure long bearing life.
- Balancing piston on larger models for counteract thrust load on bearings.
- Optimised ratios of impellers vs diffuser diameters and large turning radius of inter-stage channel for higher efficiencies.
- Each unit can be equipped with a control panel using a programmable logic controller with an operator interface for highly user-friendly operation.

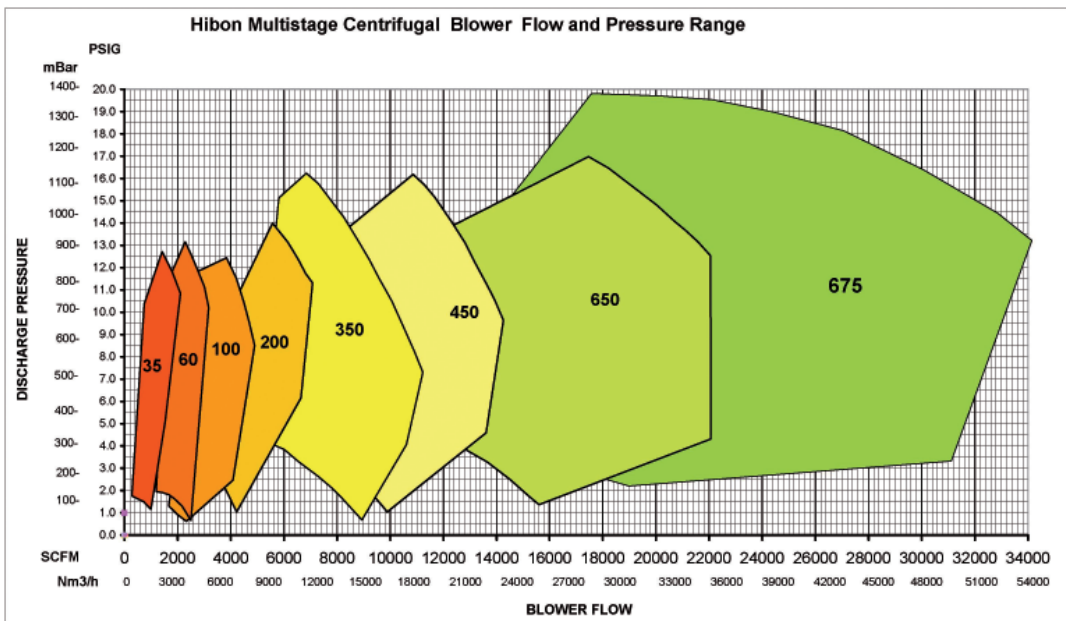
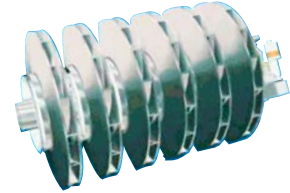

Oil Free Screw Compressors

HCS series

- Flows to 8 500 m³/h (5000 cfm)
- Pressure to 3, 5 bar (50.75 psig) gauge
- 250 mBar abs (7.4" Hg)
- Air-end manufactured from high grade cast iron directly connected to an integral gear box.
- Forged steel rotors for constant performance.
- Calculated tolerances between rotors and body to optimise efficiency.
- Anti-friction bearings optimised for maximum reliability.
- Mechanically driven oil pump from main shaft with integral oil tank and external oil/air heat exchanger.
- Complete packages including accessories and control system.



Process Blowers

These units can be designed to handle a wide variety of gases. Various materials (Cast, iron, bronze, Stainless, Steel, Titanium, Cupro...) and sealing designs are available to meet most process requirements and international standards.

- Five bearings standard, designed for V-belt or direct drive.
- Oil lubrication at both ends with large sumps.
- Wide choice of construction material to meet process requirements.
- Complete packages including accessories and control system.



• SNS Series for neutral gases

Biogas, N_2 , Ar, CH_4 , H_2 , He...

- Flows to 25 000 m³/h (14705 cfm)

- Pressure to 1,8 bar (26 psig) gauge

- Vacuum to 500 mbar abs (15 "Hg)

■ Shaft seal : lip seal, Double lip seal, single mechanical seal, double mechanical.

■ Main seal : piston ring seals, piston ring + labyrinth seals, lip seal + labyrinth seals.

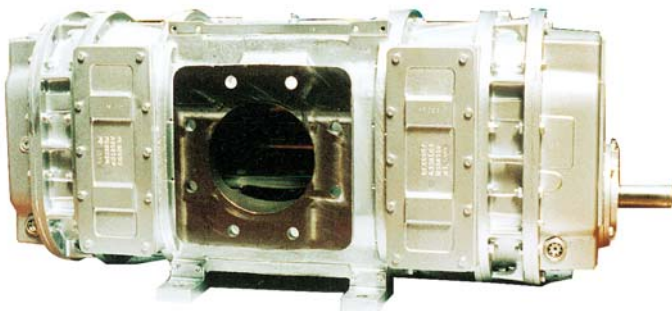

• SNP Series for dangerous gases

O_2 , O_3 , H_2S , CO_2 ...

- Flows to 25 000 m³/h (14705 cfm)

- Pressure to 1,8 bar (26 psig) gauge

- Vacuum to 500 mbar abs (15 "Hg)

■ Shaft seal : lip seal.

■ Main seal : carbon rings, double mechanical liquid seal, carbon rings + single gas lubricated seal, double gas lubricated seal.

■ 100% oil free gas guaranteed.

■ This series can be used in cryogenic applications (minimum inlet temperature up to -160 °C).

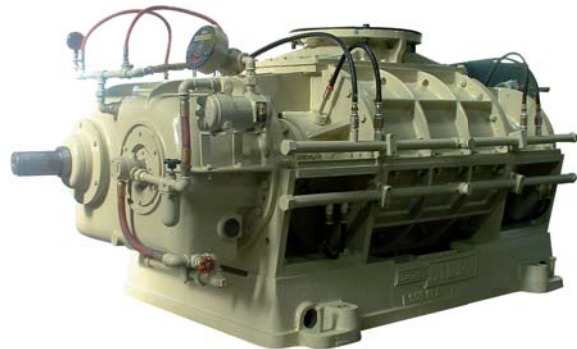



Ingersoll Rand Industrial Technologies provides products, services and solutions to enhance the efficiency and productivity of our commercial, industrial and process customers. Our innovative products include air compressors, air systems components, tools, pumps, material and fluid handling systems and microturbines.

Hibon Inc
(An Ingersoll Rand Company)
12055 Cote de Liesse
Dorval Quebec
Canada, H9P 1B4
Tel : (514) 631-3501
Fax : (514) 631-3502

Davidson IR
800 Beatty St
Davidson, NC 28036
USA

www.ingersollrand.com
www.hibon.com

Ingersoll Rand Air Solutions France
2 av. Jean Paul Sartre
59 290 Wasquehal
France
Tél : (33) 03 20 45 39 39
Fax : (33) 03 20 45 39 97

Low Pressure Business Unit / Air Solutions
11F Tower B, City Center of Shanghai,
No. 100 Zun Yi Road,
200051, Shanghai P.R.C.

Ingersoll Rand compressors are not designed, intended or approved for breathing air applications. Ingersoll Rand does not approve specialized equipment for breathing air application and assumes no responsibility or liability for compressors used for breathing air service.

Nothing contained on these pages is intended to extend any warranty or representation, expressed or implied, regarding the product described herein. Any such warranties or other terms and conditions of sale of products shall be in accordance with Ingersoll Rand's standard terms and conditions of sale for such products, which are available upon request.

Product improvement is a continuing goal at Ingersoll Rand. Designs and specifications are subject to change without notice or obligation.